

# NT6-1.2

## Characteristics

Nominal Voltage		6V
Nominal Capacity (20 hour rate)		1.2Ah
Capacity 25°C (77°F)	20 hour rate (0.06A)	1.2Ah
	10 hour rate (0.12A)	1.2Ah
	5 hour rate (0.208A)	1.04Ah
	1 hour rate (0.845A)	0.845Ah
Internal Resistance	Full Charged Battery 25°C (77°F)	≤90mΩ
Cyclic Life	50%(C <sub>20</sub> ) Depth of discharge	600Times
Float Life	25°C (77°F) Float charge at 6.9V	About 3 Years
Capacity affected by Temperature (20 hour )	40°C (104°F)	102%
	25°C (77°F)	100%
	0°C (32°F)	85%
	-15°C (5°F)	65%
Self-Discharge 25°C (77°F)	Capacity after 3 month storage	90%
	Capacity after 6 month storage	80%
	Capacity after 12 month storage	62%
Charge (Constant Voltage) 25°C (77°F)	Cycle	Initial Charging Current Less than 0.39A Voltage 7.30-7.50V
	Float	Voltage 6.75-6.90V

## Product Image



## Packing

Battery (L×W×H)	mm ± 1	97×24×57
	inch	3.82×0.95×2.25
Box (L×W×H)	mm ± 2	310×260×136
	inch	12.2×10.3×5.36
Quantity Per Box		54 PCS
Net weight Per Cell		0.30 Kg ± 10g
Net weight Per Box		16.2Kg
Gross Weight		16.5Kg

## Discharge Curve

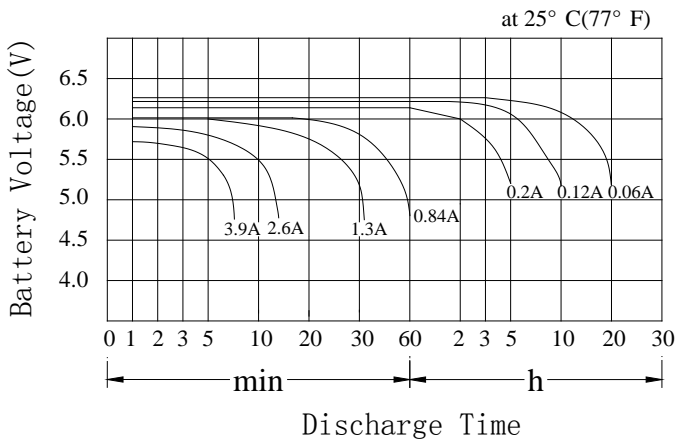

## Product Dimensions

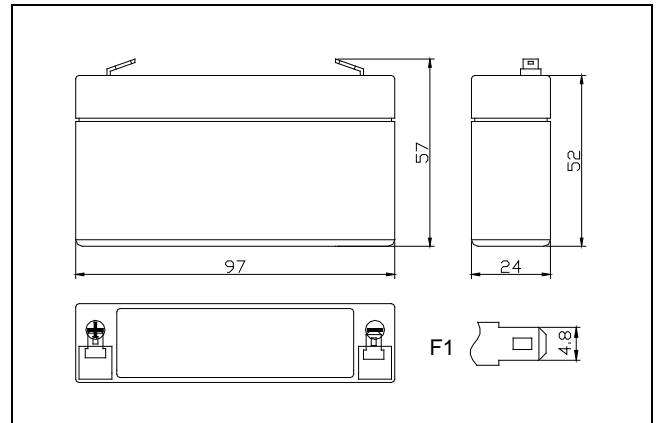

## Battery Construction

Component	Positive plate	Negative plate	Container	Safety valve	Terminal	Separator	Electrolyte
Raw Material	Lead dioxide	Lead	ABS	Rubber	Copper	Fiberglass	Sulfuric acid

## Discharge Characteristics

Voltage	Run Time (Constant Current and Power 25°C 77° F)											
	3 min	5 min	15 min	30 min	45 min	1h	2h	3h	5h	8h	10h	20h
4.8 V	28.1	24.8	14.3	8.71	6.08	4.88	2.63	1.91	1.29	0.85	0.71	0.39
5.10V	25.4	22.8	12.9	8.00	5.93	4.80	2.59	1.89	1.28	0.85	0.71	0.39
5.25V	21.1	19.9	12.2	7.54	5.86	4.72	2.55	1.86	1.28	0.84	0.70	0.38
5.40V	19.6	17.8	11.5	6.50	5.79	4.64	2.47	1.81	1.27	0.84	0.69	0.37