

# NT4-3.0

## Characteristics

Nominal Voltage		4V
Nominal Capacity (20 hour rate)		3.0Ah
Capacity 25°C (77°F)	20 hour rate (0.15A)	3.0Ah
	10 hour rate (0.285A)	2.85Ah
	5 hour rate (0.48A)	2.4Ah
	1 hour rate (1.95A)	1.95Ah
Internal Resistance	Full Charged Battery 25°C (77°F)	≤ 35mΩ
Cyclic Life	50%(C <sub>20</sub> ) Depth of discharge	600Times
Float Life	25°C (77°F) Float charge at 6.9V	About 3 Years
Capacity affected by Temperature (20 hour )	40°C (104°F)	102%
	25°C (77°F)	100%
	0°C (32°F)	85%
	-15°C (5°F)	65%
Self-Discharge 25°C (77°F)	Capacity after 3 month storage	90%
	Capacity after 6 month storage	80%
	Capacity after 12 month storage	62%
Charge (Constant Voltage) 25°C (77°F)	Cycle	Initial Charging Current Less than 0.9A Voltage 7.30-7.50V
	Float	Voltage 6.75-6.90V

## Product Image



## Packing

Battery (L×W×H)	mm ± 1	90x34x60
	inch	3.54x1.34x2.36
Box (L×W×H)	mm ± 2	342x285x82
	inch	13.5x11.2x3.2
Quantity Per Box		27PCS
Net weight Per Cell		0.40 Kg ± 15g
Net weight Per Box		10.8Kg
Gross Weight		11.1Kg

## Discharge Curve

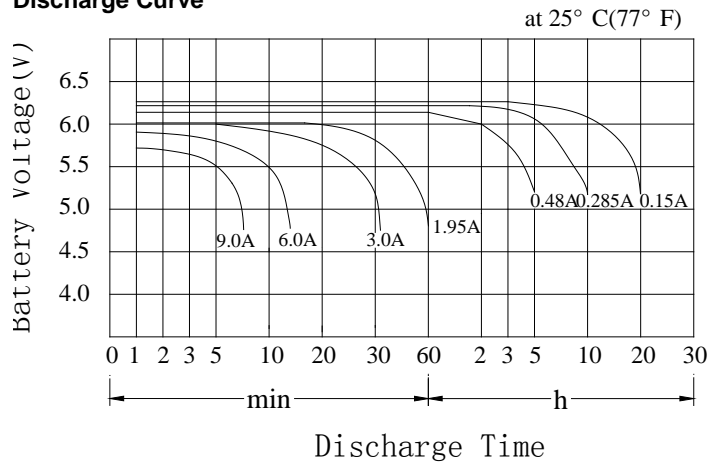

## Product Dimensions

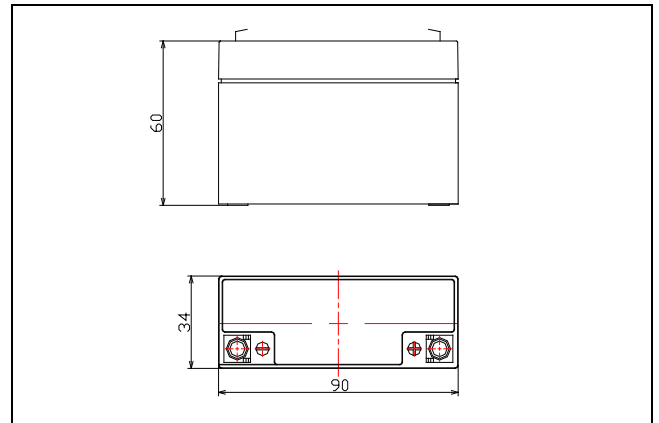

## Battery Construction

Component	Positive plate	Negative plate	Container	Safety valve	Terminal	Separator	Electrolyte
Raw Material	Lead dioxide	Lead	ABS	Rubber	Copper	Fiberglass	Sulfuric acid

## Discharge Characteristics

Voltage	Run Time (Constant Current and Power 25°C 77° F)											
	3 min	5 min	15 min	30 min	45 min	1h	2h	3h	5h	8h	10h	20h
4.8 V	43.1	38.2	22.1	13.4	9.3	7.47	4.02	2.92	1.99	1.31	1.09	0.59
5.10V	38.9	34.9	19.9	12.3	9.1	7.40	4.0	2.90	1.97	1.31	1.09	0.59
5.25V	32.5	30.7	18.8	11.6	9.0	7.27	3.9	2.87	1.97	1.29	1.08	0.58
5.40V	31.6	27.3	17.7	10.0	8.9	7.10	3.8	2.79	1.95	1.29	1.07	0.57